



**horizon
fencing**

THE FUTURE OF FENCING

**The UK's largest manufacturer
of capped composite fencing.**

Request a free sample at [bswcomposites.co.uk](https://www.bswcomposites.co.uk)



**BSW
Composites**

BSWGROUP member of binderholz



THE FUTURE OF FENCING

The UK's largest manufacturer
of capped composite fencing.

CONTENTS

| | |
|---|---------------|
| Frontier Range Introduction | Page 4 |
| Why Capped Composite | Page 5 - 7 |
| Range Colours | Pages 8 & 9 |
| Fencing Solutions | Pages 10 - 15 |
| Frontier Fencing Components | Pages 16 - 25 |
| Ordering & Contact Information. | Page 26 |
| Installation Instructions | Pages 27-35 |



Frontier Range

Brought to you by
Horizon Fencing

THE FUTURE OF FENCING



Why Capped Composite Fencing?

Only capped-composite products can deliver on the promises made by lengthy warranties.

By coating our already robust composite fencing in a layer of (almost!) indestructible HDPE, we can confidently stand behind our 20-year warranty.

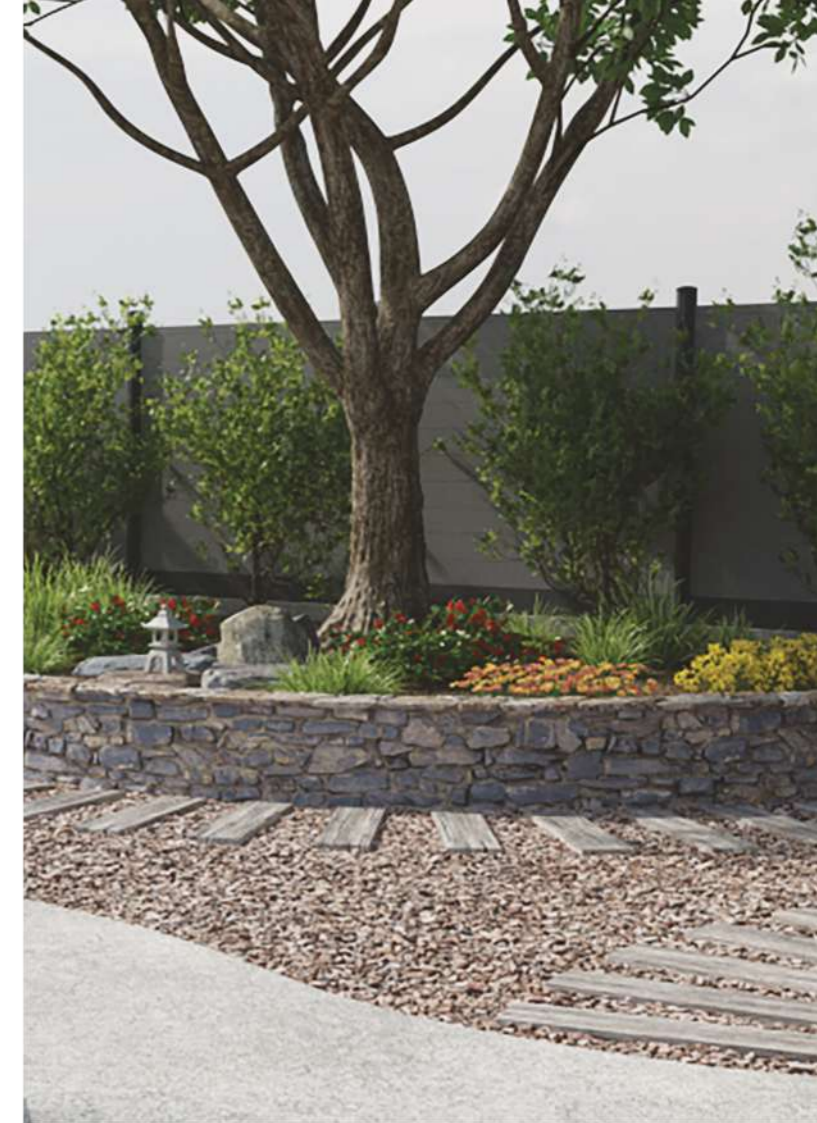

Frontier frames your home with style, strength, and simplicity.

Made right here in the UK and backed by 170 years in the timber industry, our capped composite fencing is the perfect marriage between timber and polymer.

A special blend of wood flour and recycled plastics that gives you the best bits from both worlds, capped in a durable layer of HDPE.

So, if you want to improve your horizons or just keep the nosy neighbours at bay, Frontier Fencing gives you a solid excuse to upgrade your space, without breaking the bank.



Our fence boards are completely sealed

on all 4 sides,

shutting out the pesky elements and letting you swap the paint can for a can of your favourite bevvv.

The Benefits of Capped Composite Fencing



Low Maintenance

No sanding, staining, sealing, or painting to eat into your me-time.



Eco-Friendly

Made from a blend of wood flour and recycled materials, our fencing boards are 100% recyclable. So, you can save Earth and increase your home's worth.



Weatherproof

Being 100% waterproof and able to withstand strong winds, our fencing will stand by you through any colour weather warning.



Easy Installation

Our lightweight fencing boards are easily handled and installed by simply sliding the fencing panels into the preformed grooves.

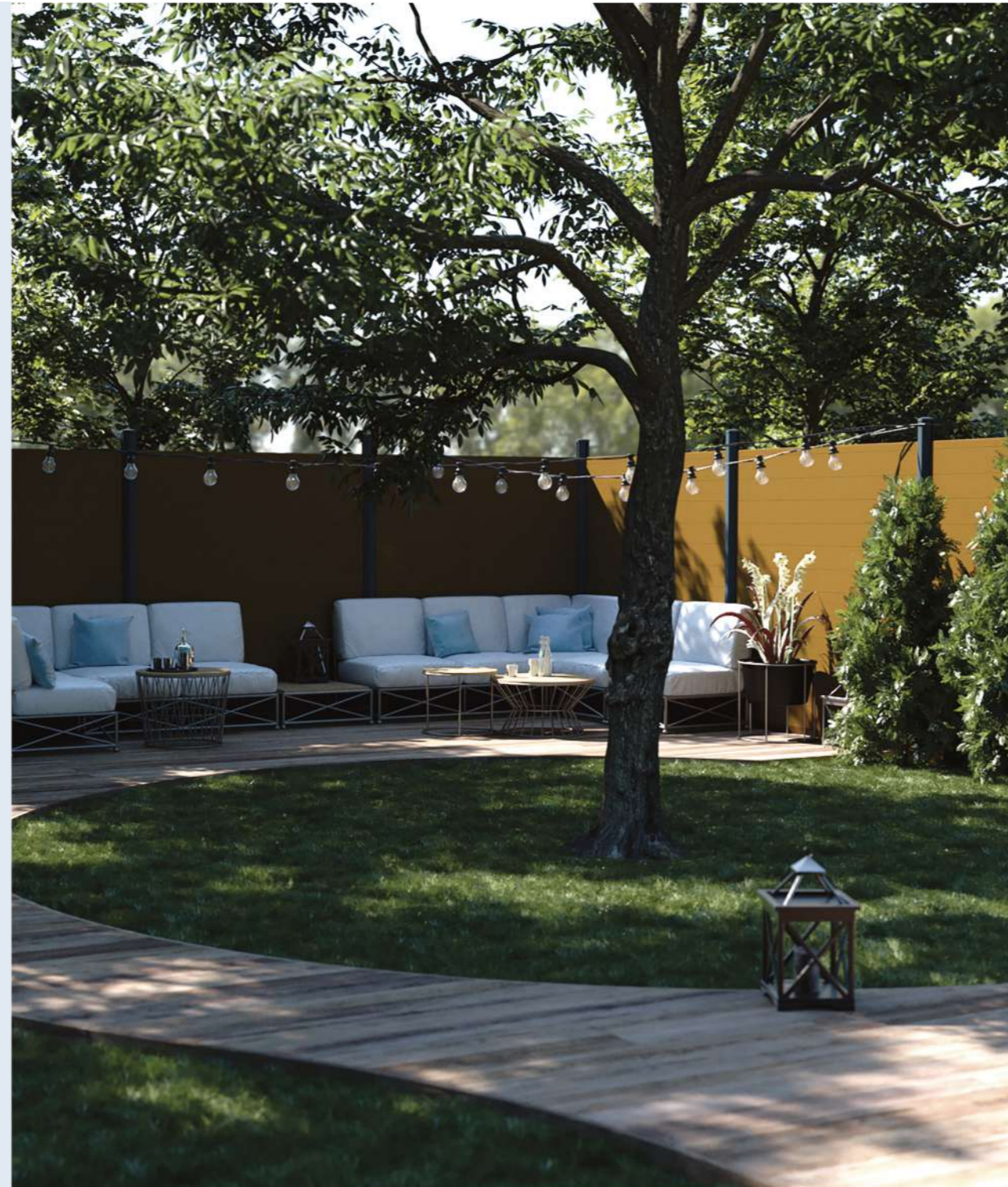

The Benefits of Capped Composite Fencing



100% Compatible

Whether installing from scratch or upgrading your existing structure, our fencing easily slots in with your current setup.



Family-friendly

With no splinters, cracks, or chips, and a surface that's mould and mildew free, you have one less "don't touch!" rule to enforce.



Quality Guaranteed

Triple your peace of mind with three quality badges: 20-year UK-Warranty, Made in Britain, and FSC® certified.



Staying Power

With built-in UV and colour stability, plus fade and stain resistance, our fencing is in it for the long haul.



Frontier Colour Options



Grizedale

Grizedale's silvery charm instantly transforms any outdoor setting into a contemporary dream.



Jura

Jura's earthy warmth is just the right shade to add a touch of spice to your garden life.



Rydal

Rydal's moody grey will turn your outdoors into a bold statement piece.



Frontier Colour Options

Frontier Fencing is available in three classic colours to add an instant touch of class to your outdoors.

No matter which shade you select, you'll have an eye-catching backdrop for your next alfresco event!

Both sides of our fence board boast a brushed embossed surface that achieves a contemporary feel with a touch of old-world charm.



Horizon Fencing Solutions

Which Fencing Solution Suits You?

Frontier Fencing is extremely versatile and easily adapts to your specific layout needs.



Horizon Fencing Solutions

Full Frontier Fencing System

Solution One

If you're building a brand-new home or planning to completely replace your old fence, then our full Frontier Fencing system is for you!

This solution easily adapts to your current layout, whether you need a wraparound fence or fencing attached to a wall.

Now all you need to do is choose one of our three classic colours!



Retrofitting with Concrete Posts

Solution Two

If your current fencing system includes concrete posts, this solution will slot right in!

Frontier Fencing boards can be trimmed to fit most setups, and easily installed using our proprietary fence post connectors that perfectly secure each board.

So, now that you don't have to start from scratch, nothing's holding you back from showing off a new fence at your next event!



Horizon Fencing Solutions

Full Frontier Fencing System

Solution One

Installing a brand-new fence can be both exciting and daunting. So, we took our merry time to make Frontier Fencing easy to install — yes, even for the severely challenged DIY-er!

This solution makes use of the following parts:

- (A) Corner Post (F) Fence Board
- (B) Standard Post (G) Fence Finishing Rail
- (C) Wall Post
- (D) Gravel Board (H) Post Cap
- (E) Stopper
- (I) Wall Post Cap

For a completely wraparound fence, you'll use a combination of corner posts (A) and standard posts (B). If your fence adjoins a wall, you'll need wall posts (C) to complete your fence.

After the posts are secured, fix a stopper (E) at the bottom of each post, then add the gravel board (D) as the foundation for your fencing boards.

Once you've created a level foundation, simply slot in the fencing boards (F), add the fence finishing rail (G), and secure with a stopper (E) at each end.

Secure post caps (H) on every standard post (B) and wall-post caps (I) on the wall posts (C).

Now ring up your family and friends to show off your fabulous Frontier Fence!

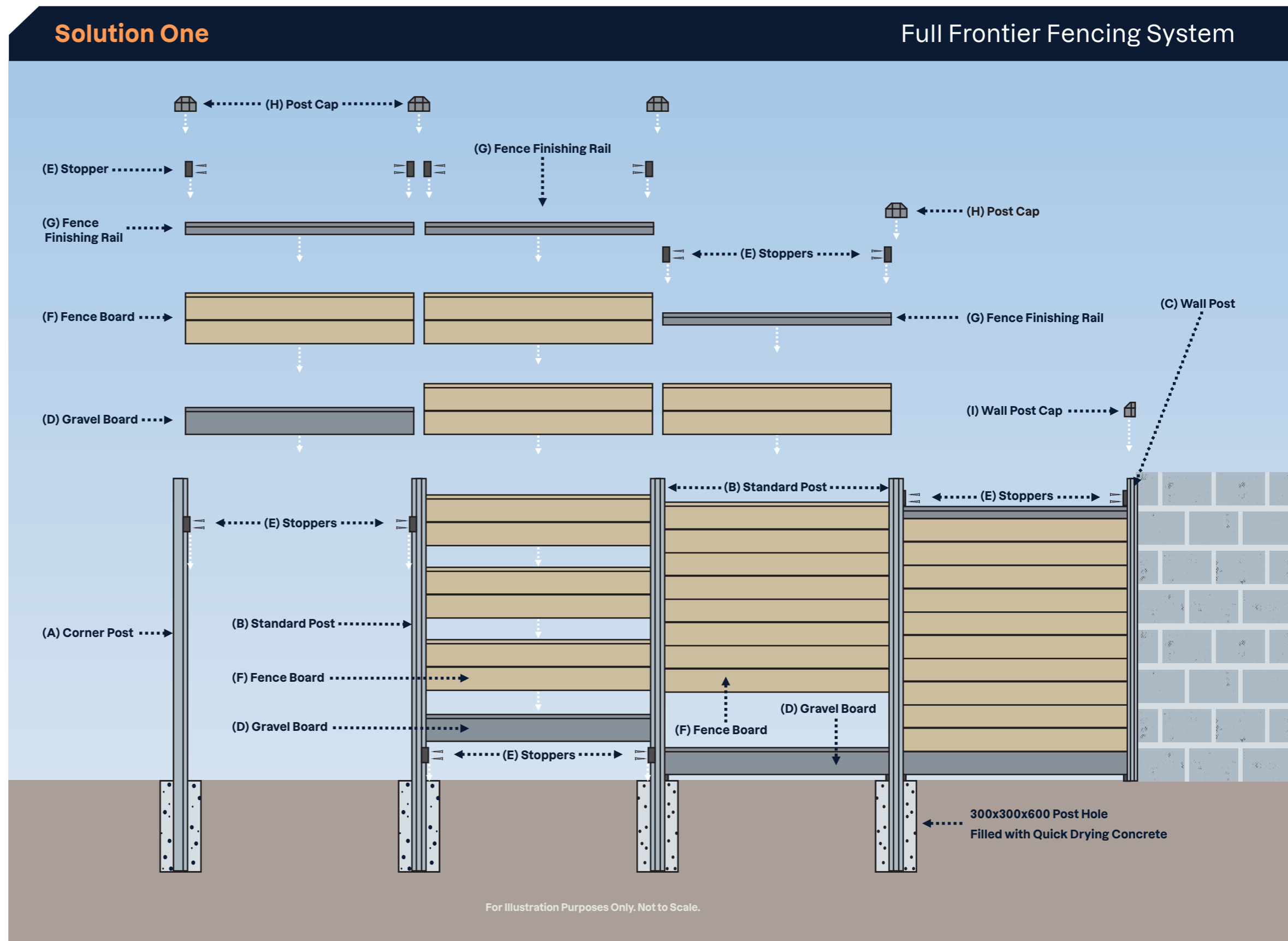

For Illustration Purposes Only. Not to Scale.

Frontier Fencing & Existing Concrete Posts

Solution Two

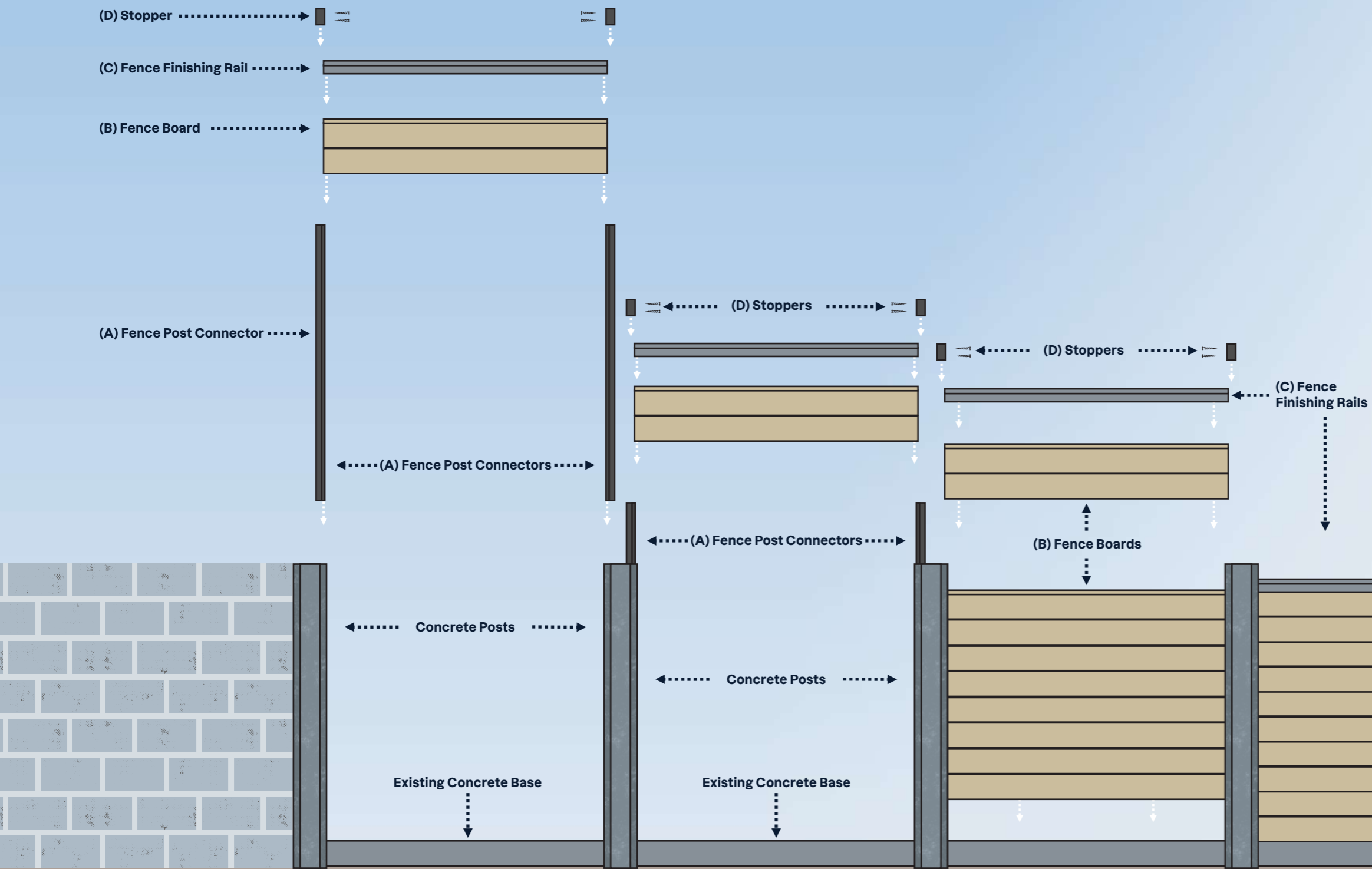

For Illustration Purposes Only. Not to Scale.

Horizon Fencing Solutions

Retrofitting with Concrete Posts

Solution Two

If you're starting off with existing concrete posts, your new Frontier Fence could be installed in a couple of hours!

You only need these four parts to transform a few concrete posts into a brand-new fence:

- (A) Fence Post Connector
- (B) Fence Board
- (C) Fence Finishing Rail
- (D) Stopper

After inserting the fence post connectors (A) into the concrete recesses, you're ready to slide in your fence boards (B)! Add the fence finishing rail (C) on top and secure with a stopper (D) at each end.

See — as easy as A, B, C, D!



Frontier Fencing Components

We've poured decades of knowledge, research, and experience into crafting each Frontier Fencing product.

Each item is designed with structural integrity and longevity top of mind, to create a fencing system that's both easy to install and super sturdy.

Ready to experience the future of fencing?



Frontier Gravel Board

FOR SOLUTION ONE

Gravel boards fit on top of the stoppers to create a level foundation for the fencing boards.

These robust PVC boards are capped in a final layer of PVC that fully protects against the harsh elements.

Hollow composition for a lightweight, easy-to-handle board, that still retains maximum structural integrity.

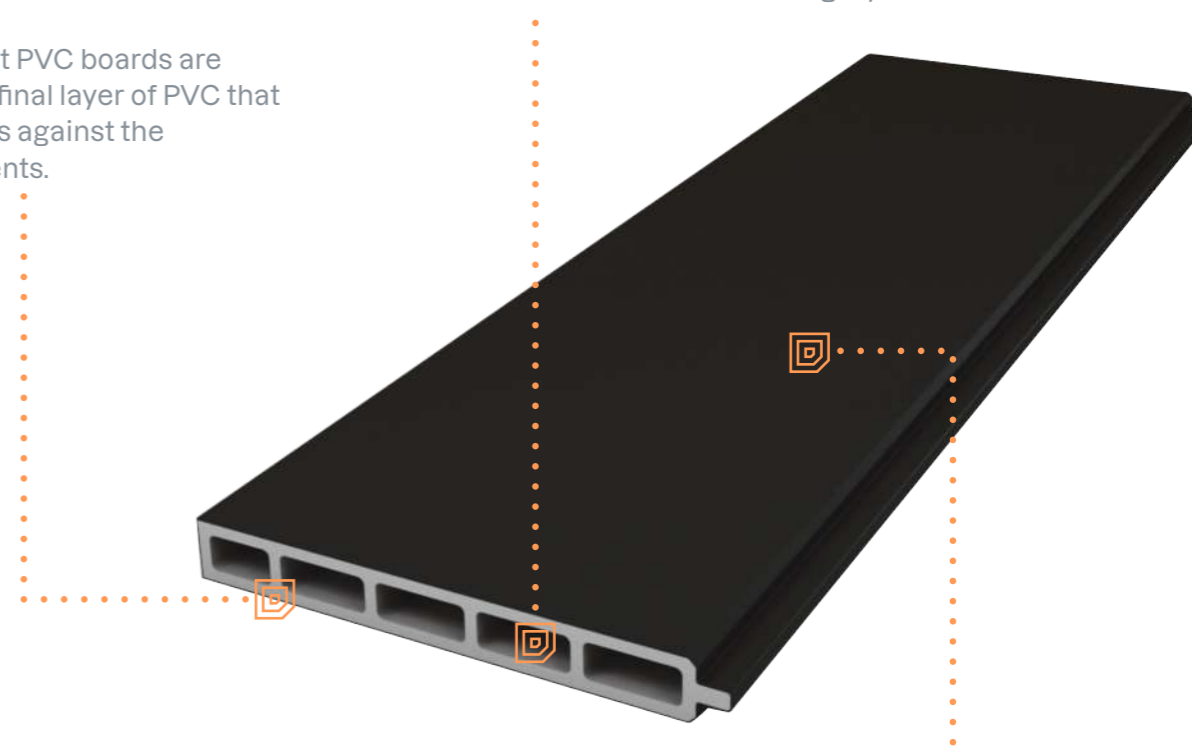

Robust composition, ideal for close contact with the ground.

Warranty



Dimensions

| | |
|-----------|-------|
| Length | Width |
| 1800mm | 150mm |
| Thickness | |
| 19mm | |

Available Colour

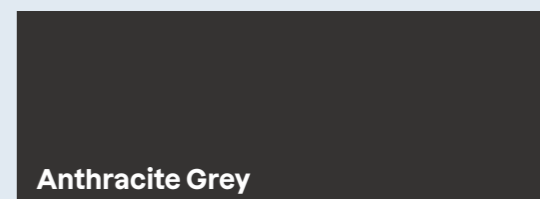

Anthracite Grey

Frontier Fence Board

FOR SOLUTION ONE & TWO

Being fully capped in a durable coating of HDPE, Frontier Fencing sports some enviable features.

Keep them handy for your next not-so-humble social session!

Your brag list:

- 20-year UK-based warranty
- Fade & stain resistant
- UV & colour stability
- Made in Britain
- FSC® certified
- Recyclable
- Won't splinter, crack or chip
- Mould & mildew resistant
- Easy to maintain
- Easy to install
- Waterproof
- Dual-sided

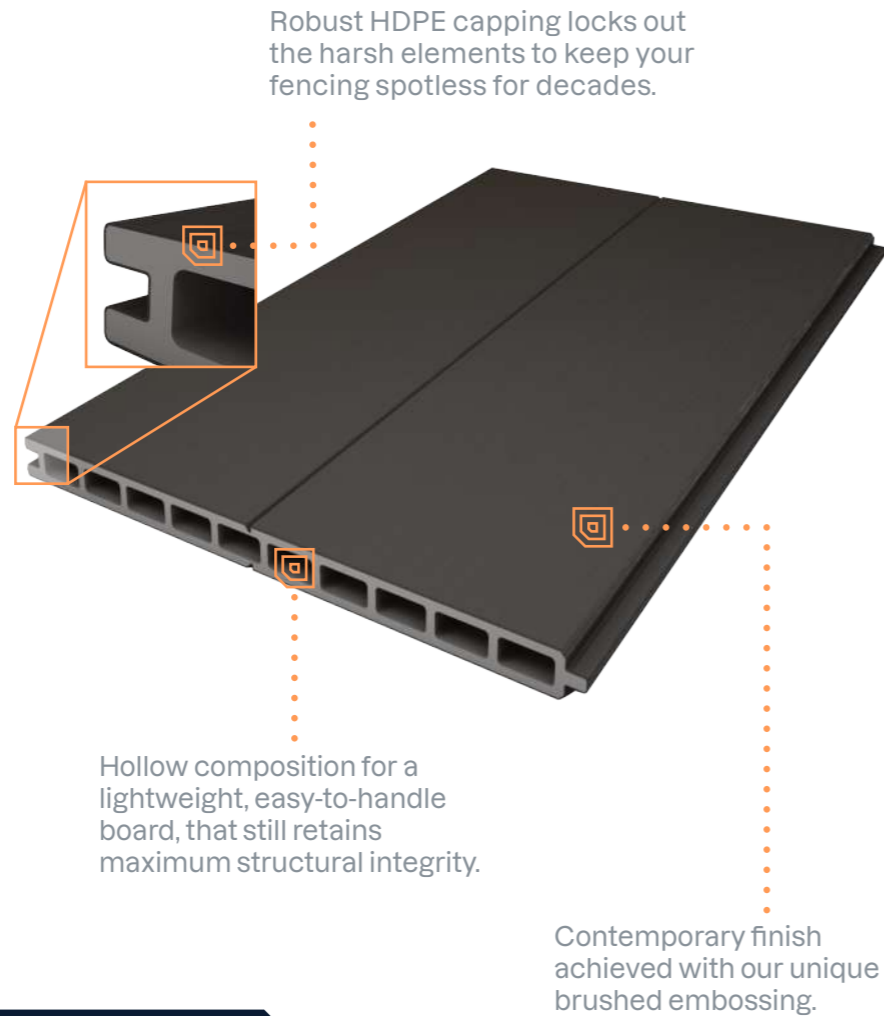

Fence Full Panel System testing based on BS EN 1794-1:20181.
Post Loading Tests based on BS EN 12839:20122.

Warranty



Dimensions

| | |
|-----------|-------|
| Length | Width |
| 1800mm | 300mm |
| Thickness | |
| 19mm | |

Available Colours

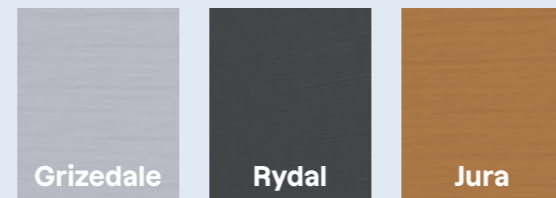

Frontier Fence Finishing Rail

FOR SOLUTION ONE & TWO

The Frontier fence finishing rail slots in on top of the fencing boards to create an attractive finishing touch.

Robust HDPE capping locks out the harsh elements to keep your fence finishing rail spotless for decades.

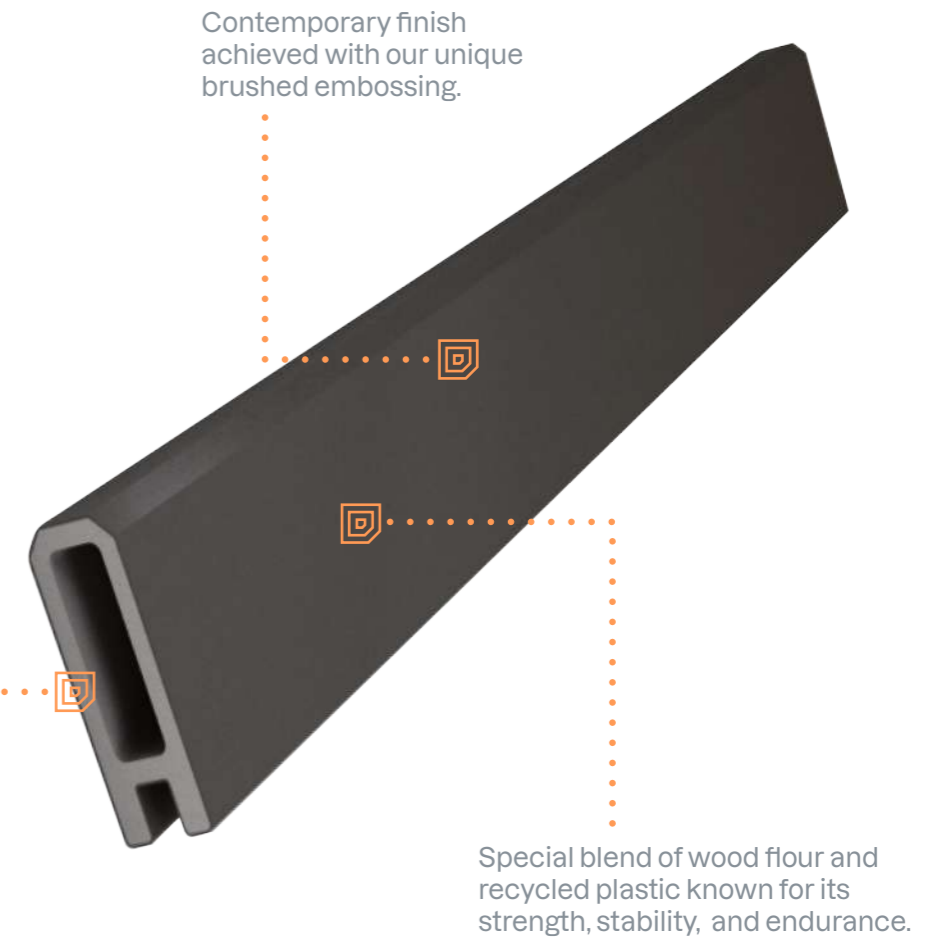

Warranty



Dimensions

| | |
|-----------|-------|
| Length | Width |
| 1800mm | 80mm |
| Thickness | |
| 19mm | |

Available Colours

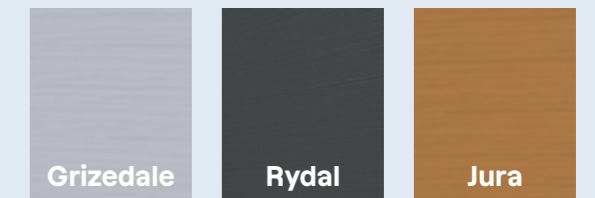

Frontier Corner Post

FOR SOLUTION ONE

Corner posts are used wherever your fencing layout calls for a 90° angle.

They're both crafted from and capped in PVC to fully protect from damage by the elements.

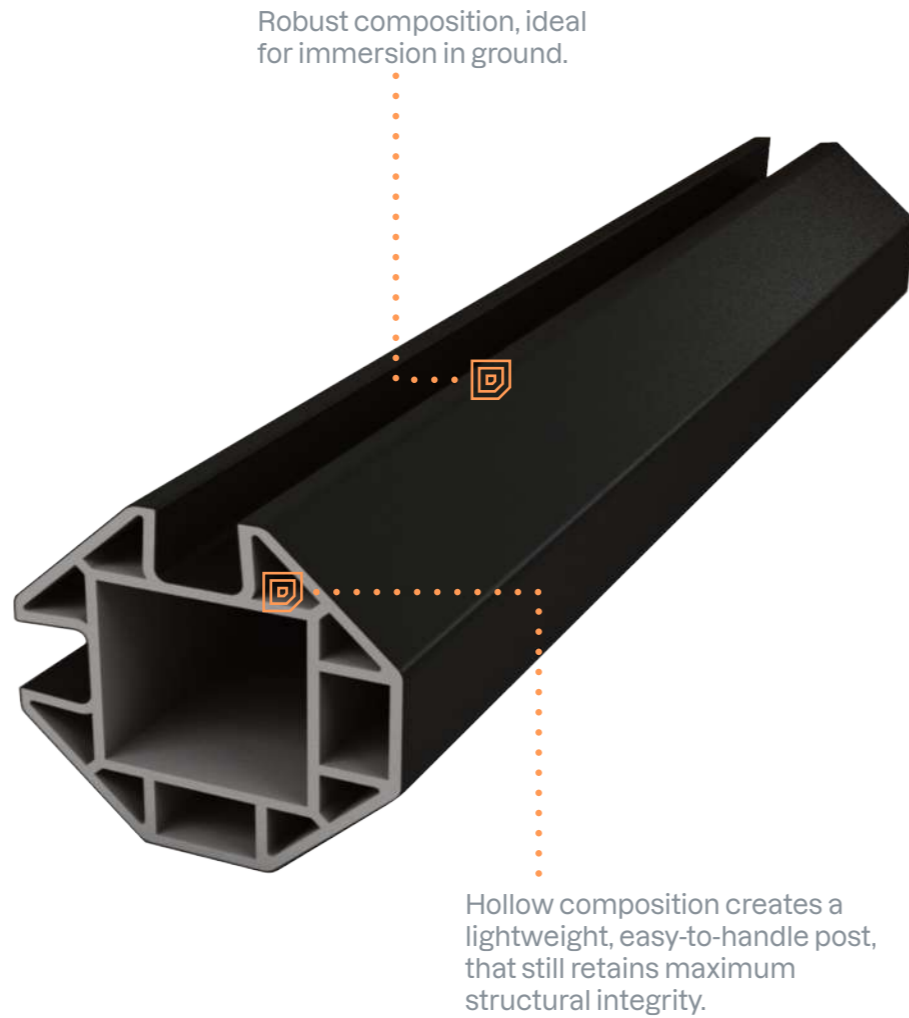

Warranty



UK-based warranty

Dimensions

Length
2700mm

Diameter
105mm

Available Colour

Anthracite Grey

Frontier Standard Post

FOR SOLUTION ONE

Standard posts connect your fence board sections along a straight line to create a sturdy structure.

These PVC posts are also capped in PVC to protect against the harsh elements.

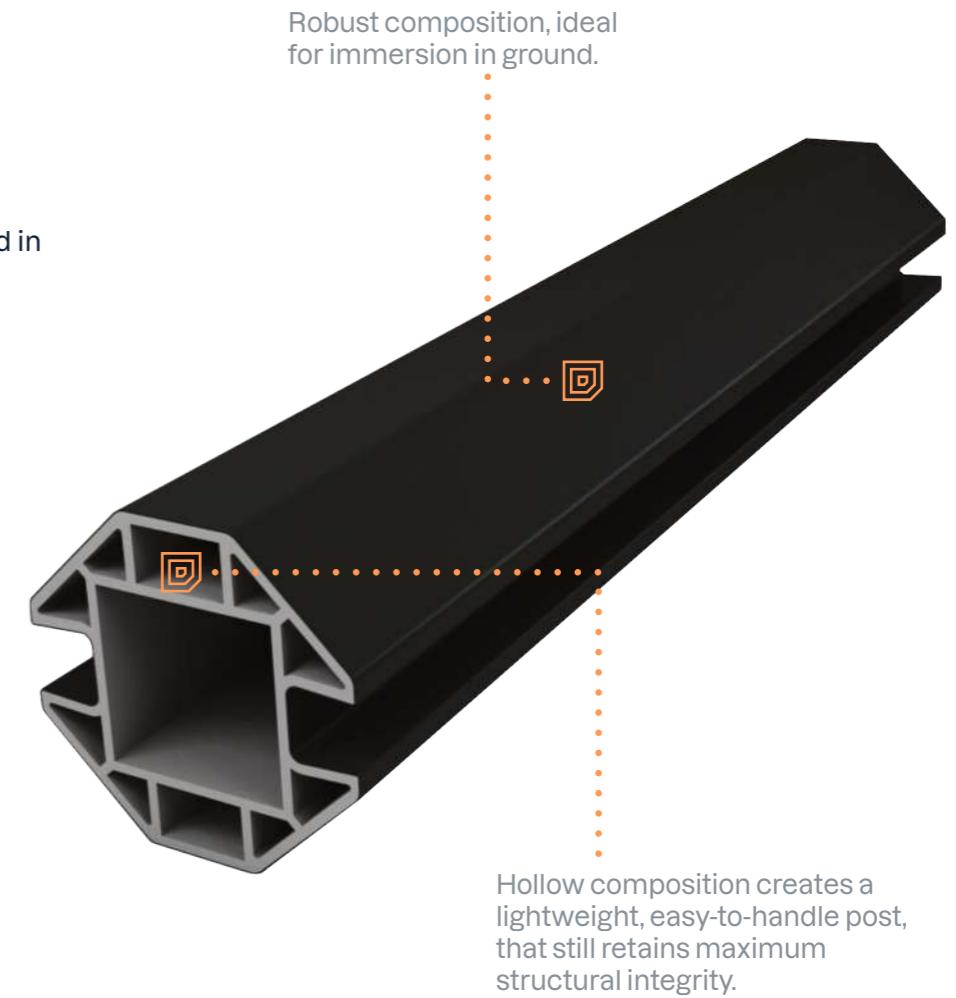

Warranty



UK-based warranty

Dimensions

Length
2700mm

Diameter
105mm

Available Colour

Anthracite Grey

Frontier Wall Post

FOR SOLUTION ONE

Wall posts can be fixed to any sturdy structure that your fence starts from or ends against.

Composed of and capped in PVC, our wall posts are sure to stand the test of time.

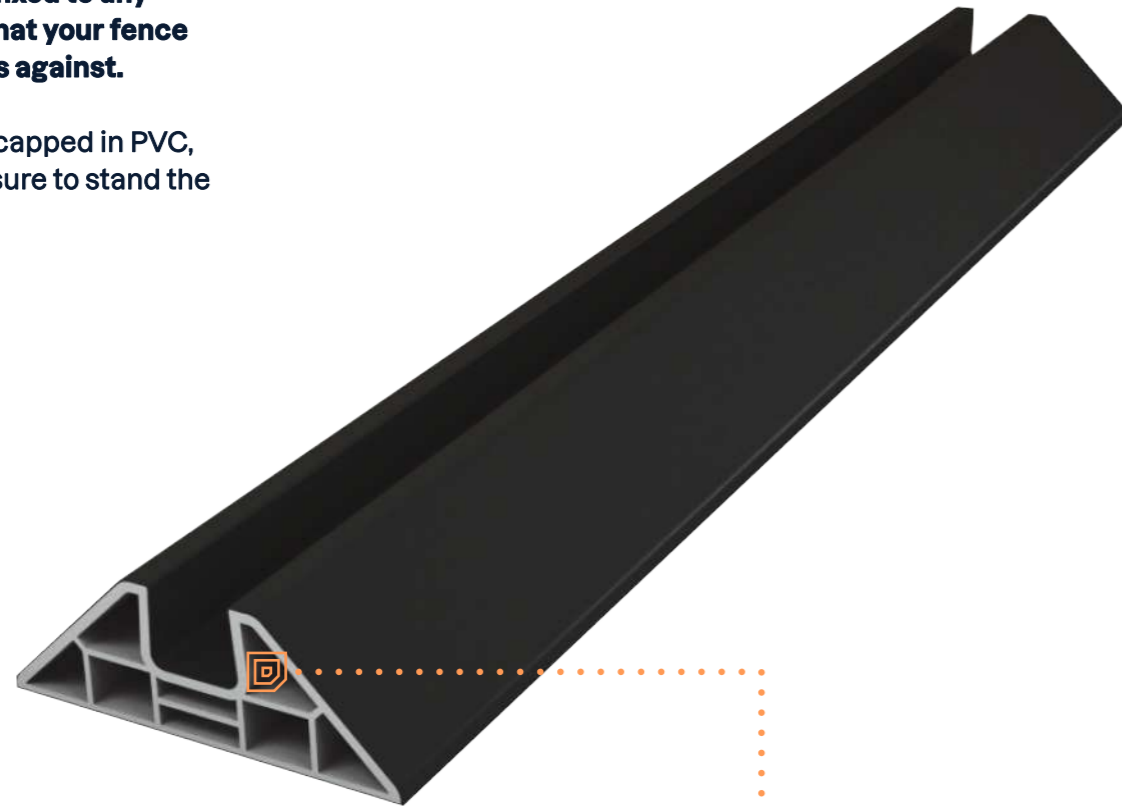

Hollow composition creates a lightweight, easy-to-handle post, that still retains maximum structural integrity.

Warranty

20 YEAR
WARRANTY

UK-based warranty

Dimensions

| | |
|--------|-------|
| Length | Width |
| 2700mm | 105mm |

| |
|-----------|
| Thickness |
| 40mm |

Available Colour

Anthracite Grey

Frontier Fence Post Connector

FOR SOLUTION TWO

Our fence post connector is the magic bullet that transforms your concrete posts into Frontier fencing posts!

They're crafted from durable PVC to create a robust framework for your future fence.



Weathering-resistant composition for maximum durability.

Warranty

20 YEAR
WARRANTY

UK-based warranty

Dimensions

| | |
|--------|-------|
| Length | Width |
| 2400mm | 47mm |

| |
|-----------|
| Thickness |
| 28mm |

Available Colour

Anthracite Grey

Frontier Wall Post Cap

Wall post caps fit firmly over your wall posts — the final addition to your future fence.

| | |
|---|------------------------|
| 20 YEAR WARRANTY UK-based warranty | Available Colour |
| | Anthracite Grey |

FOR SOLUTION ONE

Made from polypropylene for maximum toughness.



Frontier Post Cap

Post caps fit snugly on your corner and standard posts — the finishing touch to your Frontier Fence.

Composed of polypropylene, it can easily withstand being pelted with rain, 364 days of the year.

| | |
|---|------------------------|
| 20 YEAR WARRANTY UK-based warranty | Available Colour |
| | Anthracite Grey |

FOR SOLUTION ONE

Made from polypropylene for maximum toughness.



Frontier Stopper

FOR SOLUTION ONE & TWO

Stoppers are multi-purpose, creating a level base for your fencing boards and securing the fence finishing rail.

Made from polypropylene for maximum toughness.

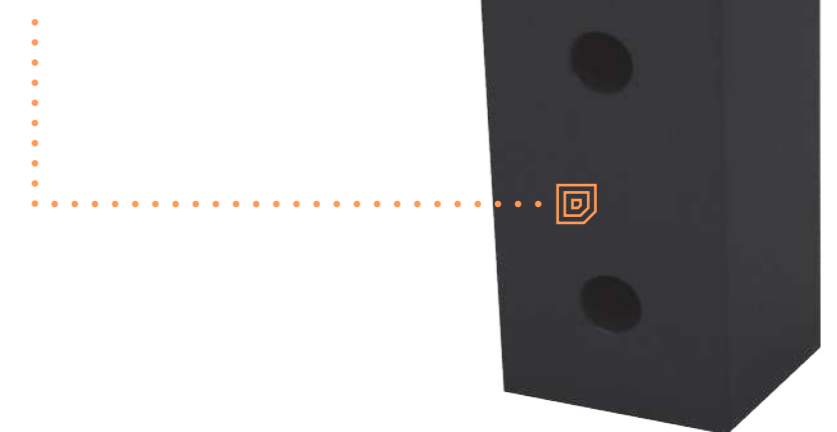

Warranty

| |
|---|
| 20 YEAR WARRANTY UK-based warranty |
| |

Available Colour

| |
|--------------|
| Black |
|--------------|



Ordering Information



Installation Guide

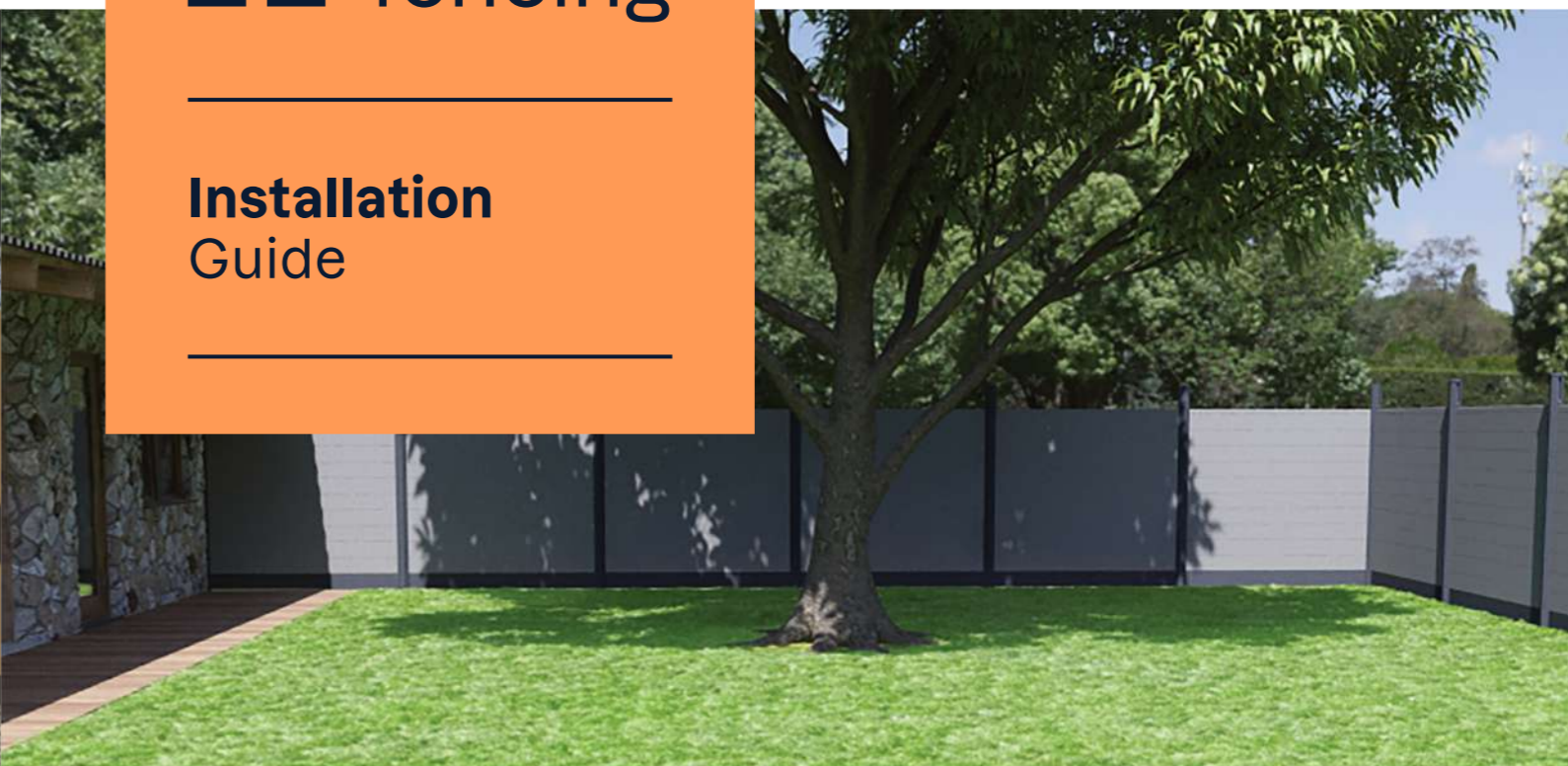

Ordering

Ready to upgrade your garden and start collecting the compliments?

Head over to our website and find the stockist closest to you!

bswcomposites.co.uk

Care Guide

Although Frontier Fencing requires minimal maintenance, there are a few do's and don'ts to maximise the lifespan of your fence.

Head over to our website and get your copy:

bswcomposites.co.uk

Need more Information?

Queries

Need to speak to us?

Call, email or send some smoke signals, we're happy to chat!

0800 587 8887

hello@bswcomposites.co.uk

Technical info

All our products have undergone stringent tests to make sure you get only the best.

For in-depth reports, please download the specifications on our website:

bswcomposites.co.uk

Congrats on your Frontier Fence!

We're sure you'd like to get going asap, and our guide will make sure you've got all you need for a proper installation. Here's a handy checklist of *must-dos* and *must-knows* before you jump in.

Preparation List

- **Measure and map out your fencing solution before starting installation.**
- **Store fencing boards flat until use.**
- **Only install fencing at temperatures above 0 degrees.**
- **Only use Frontier fittings and screws for best results and to preserve your warranty.**
- **Don't over-tighten the screws; tighten just until they're flush with the post.**
- **If two posts are less than 1.8m apart (recess edge to recess edge), you can cut the fencing board to the correct size without affecting your guarantee or the board's integrity.**

Frontier Tools Guide

The tools you need depend on your chosen fencing solution, but you'll need the below essentials in most cases:

| | | | |
|----------------|--------------|--------------|----------|
| Safety Goggles | Spirit Level | Screwdriver | Shovel |
| Rubber Mallet | Hand Drill | Dust Mask | Chop Saw |
| Safety Gloves | Drill Bits | Tape Measure | Hack Saw |



Frontier Parts Guide

Follow the below parts guide for your specific fencing solution:

| Solution One | | Full Frontier Fencing System | |
|--|-----------------------------------|-----------------------------------|--|
| Frontier Gravel Board | Frontier Corner Post | Frontier Post Cap | |
| Frontier Fence Board | Frontier Wall Post | Frontier Wall Post Cap | |
| Frontier Fence Finishing Rail | Frontier Standard Post | Frontier Stopper | |

| Solution Two | | Frontier Fencing & Existing Concrete Posts | |
|--|--|--|--|
| Frontier Fence Post Connector | Frontier Fence Finishing Rail | | |
| Frontier Fence Board | Frontier Stopper | | |

Installing Your Fence Solution 1 - Full Frontier Fencing System

Placing Posts

You'll need to secure your posts approximately 24 hours before adding the fence boards, when the concrete is 100% set. (Follow the manufacturer's guidelines for the specific concrete mix you are using.)

Only secure two posts at a time, ensuring your measurements are correct before starting the next section.



01: Mark the two post locations 1865mm apart, centre to centre. This allows the 1.8m fence boards to slot into place when the posts are set.

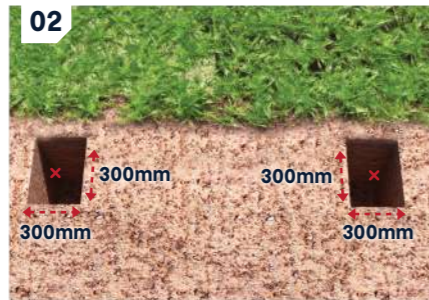

02: Keeping the marked spot as your centre, dig a 600mm hole, 300mm x 300mm wide.

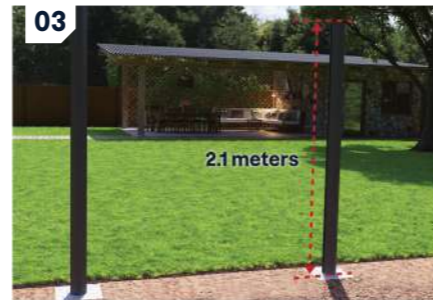

03: Insert the first post, making sure it's 2.1m above ground level.



04: Following the manufacturer's guidelines, fill the hole with concrete, using supports and a spirit level to ensure it stays level on all sides.



05: Place the second post and repeat, making sure the distance between posts stays 1.8m, recess edge to recess edge.

Installing Your Fence Solution 1 - Full Frontier Fencing System

Wall Post

If your fence starts or ends against a wall, you'll need to fix a wall post to the wall:



01: Before fixing the post to the wall, you'll need to pre-drill 5 pilot holes and counter sinks using a 4mm countersink drill bit.

Place the post on a sturdy work-surface and drill holes at 50mm, 550mm, 1050mm, 1550mm and 2050mm.

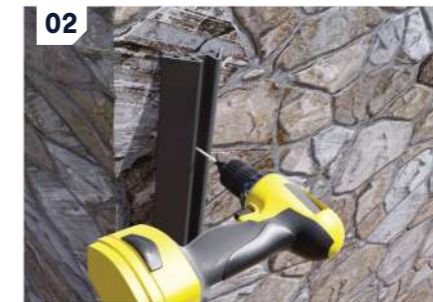

02: Level the wall post against the wall, keeping it straight and firmly on the ground.

Using a 5mm masonry drill bit, drill 50mm pilot hole at the top into the wall.



03: Use the supplied screws to fix the post to the wall, taking care to not over-tighten.

Adding Fence Boards



01: Insert the stopper at the top of the wall post, sliding it right to the bottom.



02: Fix the stopper to the wall with two screws.



03: Repeat on the other post ensuring both stoppers are level.

Installing Your Fence Solution 1 - Full Frontier Fencing System

Adding Fence Boards - Continued



04: Insert the gravel board at the top of both posts and slide it down to the ground.



05 Using a spirit level, make sure the board is 100% level.



06: Slot in the first fencing board, ensuring it is level before adding the other boards. Each board should sit firmly on the last, similar to tongue and groove.



07: Add the fence finishing rail.



08: Slide a stopper onto each post to sit above the fence finishing rail.



09: Use two screws to fix each stopper into place.



10: Place a half cap onto the wall post and secure with a rubber mallet.

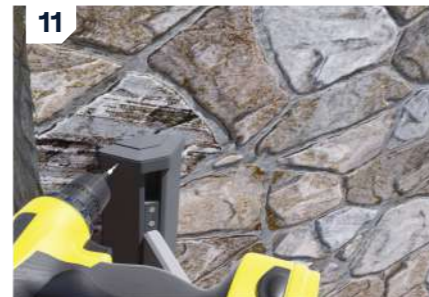

11: Using a 3mm drill bit, drill two pilot holes into the post, using the two predefined holes on the cap as a guide.



12: Fix the cap to the post with the supplied screws.

Installing Your Fence Solution 1 - Full Frontier Fencing System

Adding Fence Boards - Continued



13: Repeat on the other post, starting with a full cap.



14: When finishing your fence, the distance between your second last and last post might be less than 1.8m.

Simply measure the distance between the two posts, recess edge to recess edge, and cut your boards accordingly.



Installing Your Fence Solution 2 - Frontier & Existing Concrete Posts

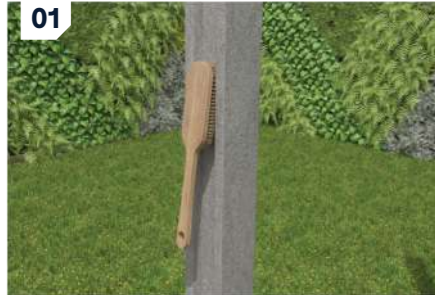

01: Thoroughly clean your existing concrete posts with a wire brush.



02: Before inserting the fence post connector and fixing it to the concrete post, you'll need to pre-drill 4 pilot holes and counter sinks using a 4mm countersink drill bit. Place the fence post connector on a sturdy work-surface and drill holes at 50mm, 700mm, 1350mm, and 2050mm.

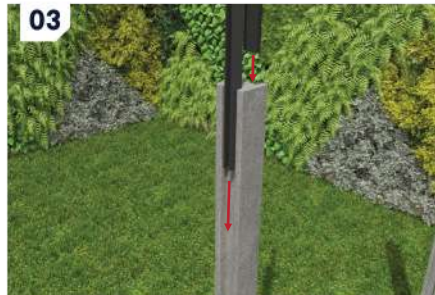

03: Insert the fence post connector into the concrete post recess and use a 4mm masonry drill bit to drill 30mm pilot holes. Ensure the fence post connector is straight before continuing.



04: Starting at the bottom, fix the fence post connector to the concrete post with the supplied screws. Don't over-tighten.



05: Next, fix the top of the fence post connector to the concrete post with the supplied screws.



06: Lastly, fix the centres of the fence post connector with the supplied screws.



07: Once all fence post connectors are secured, slot 5 fencing boards in one by one, making sure each fits firmly on the bottom board, before stacking on the rest.



08: Add the fence finishing rail.

Installing Your Fence Solution 2 - Frontier & Existing Concrete Posts



09: Slide a stopper onto each post to sit above the fence finishing rail.



10: Use two supplied screws to fix each stopper into place.



11: Now grab your phone and send out the invites to next week's Sunday roast!





Request a free sample box via our website to get a feel for our composite fencing yourself - [bswcomposites.co.uk](https://www.bswcomposites.co.uk)



0800 587 8887



hello@bswcomposites.co.uk



[bswcomposites.co.uk](https://www.bswcomposites.co.uk)

 horizon
fencing



BSW
Composites

BSWGROUP member of binderholz ■



The mark of
responsible forestry

 MADE IN
BRITAIN[®]